



PRICELIST

**NEW
ITEM**

2024-2025

AVAILABLE!

NEW ITEM

ROTARY TOOL KIT SET DGA 418 (418PCS)

Order No.	Type	Price /Set	Pak/Dos
25-8128-0418	DGA-418(418Pcs)	540,000	1/10

NEW

- 20Pcs Sanding Bands : 1/4" x 1/2"
- 16Pcs Sanding Bands : 3/8"x1/2"
- 20Pcs Sanding Bands: 1/2" x 1/2"
- 6Pcs grinding wheels with shank
- 6Pcs grinding wheels with shank
- 6Pcs baigang jades and wheels with shank
- 1Pcs diamond cut off wheel
- 2Pcs rubber emery wheel : 1/8" x 7/8"
- 1Pcs wrench : 3/8"
- 2Pcs felt wheel : 1" x 1/4"
- 6Pcs felt wheel : 1/2" x 1/4"
- 2Pcs felt wheel pointed
- 1Pcs dressing stone : 1" x 3/8"
- 1Pcs flap wheel
- 1Pcs flap wheel 1 1/4" x 3/8"
- 10Pcs fiberglass cut off wheels
- 4Pcs collets : 1/16", 3/32" x2, 1/8"
- 50Pcs bottled sand papers
- 50Pcs bottled sand papers

- 50Pcs bottled sand papers
- 50Pcs bottled sand papers
- 30Pcs cut off wheels heavy duty : 15/16" x 1/32"
- 36Pcs cut off wheels regular : 15/16" x 1/64"
- 9Pcs hss twist drills : 1/16" x 3, 3/32" x 3, 1/8" x 3
- 1Pcs hss cutters
- 10Pcs diamond cutters
- 3Pcs rubber grinding stones
- 1Pcs mandrels for wheel
- 2Pcs mandrels for wheel
- 1Pcs sanding shanks : 1/4" x 1/2"
- 1Pcs sanding shanks : 3/8" x 1/2"
- 1Pcs sanding shanks : 1/2" x 1/2"
- 6Pcs grinding wheels with shank

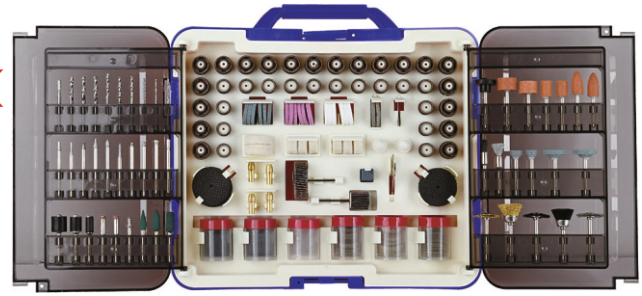

Shank (Ø3.1 mm)

- 1Pcs sucking disc
- 4Pcs grinding wheels with shank
- 2Pcs wire polishing brush
- 3Pcs nylon polishing brush
- 2Pcs copper wire polishing brush



NEW ITEM

KUNCI SOCK RATCHET KEPALA PALU

Order No.	Size	Price	Pak/Dos
72-3616-1719	17 x 19	230,000	9/36
72-3616-1721	17 x 21	235,000	9/36
72-3616-1921	19 x 21	245,000	9/36
72-3616-1922	19 x 22	250,000	9/36
72-3616-1924	19 x 24	260,000	9/36
72-3616-2123	21 x 23	265,000	9/36

NEW 3 FUNGSI



CUKIT PAKU MOD. MOKUBA JP

Order No.	Size	Length	Price	Pak/Dos
62-3837-10	10"	250mm	120,000	6/60
62-3837-12	12"	300mm	160,000	6/36



ROLLER SHACKLE

Order No.	Type	Capacity	Price	Pak/Dos
28-1851-0300	RS-3000	3T	435,000	1/10
28-1851-0400	RS-4000	4T	750,000	1/6
28-1851-0500	RS-5000	5T	980,000	1/4

Type	WLL (T)	Dia. of Rope		D1 (mm)	A	D2 (mm)	Weight (Kg)
		D (mm)	D				
RS-3000	3	34	23.5	43.2	24	2.25	
RS-4000	4	38	27.5	51	27	3.62	
RS-5000	5	45	29.5	61	28.8	5	

WLL = Batas Beban Kerja



NEW

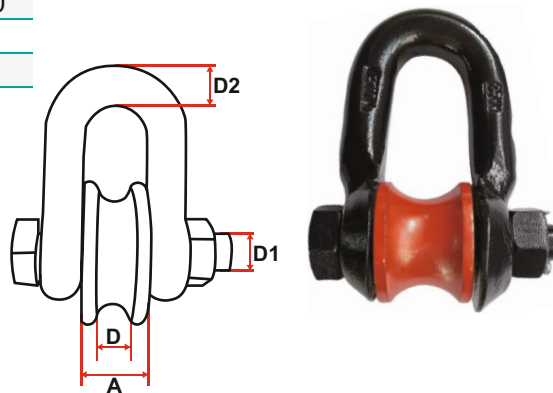

ROLLER SHACKLE

Order No.	Type	Capacity	Price	Pak/Dos
28-1851-1200	RS-12000H	12T	1,125,000	1/5
28-1851-1700	RS-17000H	17T	1,500,000	1/4
28-1851-2500	RS-25000H	25T	2,400,000	1/2
28-1851-3500	RS-35000H	35T	3,850,000	1/2
28-1851-5500	RS-55000H	55T	7,300,000	0/1

Type	WLL (T)	Dia. of Rope		D1 (mm)	A	D2 (mm)	Weight (Kg)
		D (mm)	D				
RS-12000	12	25	35	44	33	6.15	
RS-17000	17	36	41	55	38	10.94	
RS-25000	25	40	51	64	45	17.77	
RS-35000	35	43	55	74.5	51	26.54	
RS-55000	55	56	70	93.5	66	46.36	

WLL = Batas Beban Kerja



NEW

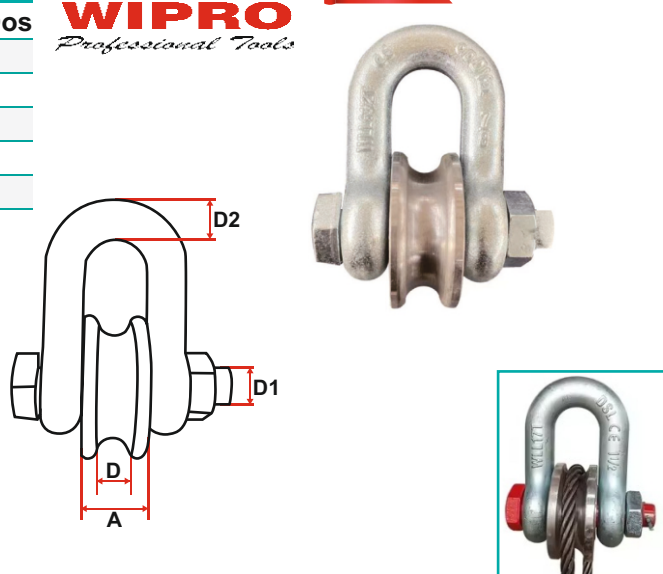

NEW ITEM

MATA GERINDA BEVEL (ROUND EDGE)

Order No.	Type	Size	Thickness	Price	Pak/Dos
84-8010-7515	DGR-7515	75x15x20mm	15mm	110,000	5/50
84-8010-7520	DGR-7520	75x20x20mm	20mm	150,000	5/50

NEW

- Outsize : 75mm
- Mounting Hole Size : 20mm
- Insize : 45mm
- Material : 65Mn
- Grits : 50/60 Mixed Sand

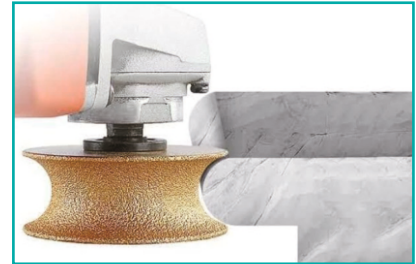

- Cocok untuk berbagai aplikasi seperti pemotongan ubin, pembentukan batu, penghalusan meja, dll.

MATA GERINDA BEVEL (FRENCH EDGE)

Order No.	Type	Size	Thickness	Price	Pak/Dos
84-8012-7515	DGF-7515	75x15x20mm	15mm	110,000	5/50
84-8012-7520	DGF-7520	75x20x20mm	20mm	150,000	5/50

NEW

- Outsize : 75mm
- Mounting Hole Size : 20mm
- Insize : 44mm
- Material : 65Mn
- Grits : 50/60 Mixed Sand



- Cocok untuk berbagai aplikasi seperti pemotongan ubin, pembentukan batu, penghalusan meja, dll.

BOR TANGAN MANUAL SET

Order No.	Type	Price /Set	Pak/Dos
82-1470-021	MDB-21	110,000	1/200

NEW

- Handle Length : 90mm
- Material of Bits : HS4241
- Bits Size (20Pcs) : 0.3, 0.35, 0.4, 0.45, 0.5, 0.55, 0.6, 0.65, 0.7, 0.75, 0.8, 0.85, 0.9, 0.95, 1.0, 1.2, 1.3, 1.4, 1.5, 1.6mm



20Pcs Bits



ALAT PRESS HIDROLIK BUKA BAN

Order No.	Type	Price	Dos
47-1400-0000	ABB-1	4,500,000	1

NEW



Pakai Kompresor

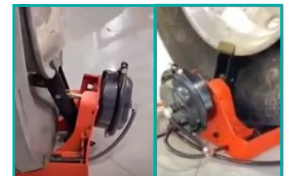

- Working Air Pressure : 0.8-1.2 MPA (8-12 Bar)
- Suitable Tire Model : 16/17.5/19.5/22.5 Vacuum
- Max Width of Tire : 30 cm
- Tire Thickness : 13.5 - 20.5cm
- Dimension Produk : 745x555x293mm
- Packing Size : 57x42x29cm
- N.W. / G.W. : 33 / 38Kg



NEW ITEM

MAGNETIC FLOOR SWEEPER WITH QUICK RELEASE

Order No.	27-0450-0000	27-0600-0000	27-0750-0000	27-0900-0000
Type	MFS-450	MFS-600	MFS-750	MFS-900
Price	1,000,000	1,125,000	1,270,000	1,410,000
Size	18"x3"x4"	24"x3"x4"	30"x3"x4"	36"x3"x4"
Suction	30-50lbs	30-50lbs	30-50lbs	30-50lbs
Handle Length	30"-44.5"	30"-44.5"	30"-44.5"	30"-44.5"
Wheel Dia.	160mm	160mm	160mm	160mm
Magnet	4pcs	4pcs	6pcs	8pcs
Weight	6kg	7kg	8kg	9.5kg
N.W./G.W.	12/13Kg	14/15Kg	16/17Kg	19/20Kg
Meas.	79x23x42cm	79x23x42cm	94x23x42cm	108x23x42cm
Dos	2	2	2	2

NEW

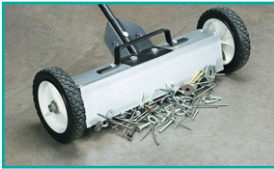

MFS SERIES

MAGNETIC SWEEPER

Order No.	27-1321-0000	27-2821-0000
Type	MS-13	MS-28
Price	550,000	700,000
Size	13"x2"x1"	28"x2"x1"
Suction	30lbs	30lbs
Handle Length	30"-44.5"	30"-44.5"
Wheel Dia.	180mm	180mm
Magnet	4pcs	6pcs
Weight	3.75kg	4.75kg
N.W./G.W.	15/16Kg	19/20Kg
Meas.	80x27x21cm	80x27x21cm
Dos	4	4

NEW



MS SERIES

NEW ITEM

POMPA SEPEDA TABUNG BESI + METER

Order No.	Type	Price	Pak/Dos
61-3867-	WP3867	130,000	1/20



- Size of Cylinder : Ø38x610mm
- High Pressure 160 PSI
- Iron Body
- Handle Plastic PP
- Hose Length : 79cm
- Dial Gauge 50mm with Tank
- N.W. / G.W. : 0.775 / 0.725kg



- MOTORBIKE, BICYCLES, MOPEDS & E-BIKES
- INFLATABLE BOATS, TOYS AND BALLS
- BUILT-IN PRESSURE GAUGE
- COMPATIBLE WITH PRESTA & SCHRADER VALVES
- SET OF NOZZLES

BATTERY TERMINAL SET (POSITIF + NEGATIF)

Order No.	Type	Price /Set	Pak/Dos
36-2018-1618	BT-2018	120,000	10/100



- Size : 18mm+16mm
- Material : Brass
- N.W. / G.W. : 0.227 / 0.235Kg

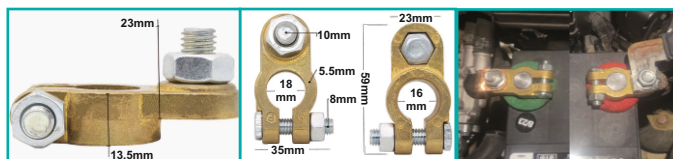

SOCKET DISPLAY SET 80PCS

Order No.	Type	Price /Set	Dos
97-1200-31	SD-80	370,000	18 Set



- Overall Size : 51x15.5cm
- Qty 1/4" : 26Pcs
- Qty 3/8" : 30Pcs
- Qty 1/2" : 24Pcs
- Weight : 1Kg

SOCKET PLUG U/ SD-80

Order No.	Size	Head Size	Price	Pak
97-1200-301	1/4"	6.35x6.35mm	4,000	25
97-1200-302	3/8"	9.5x 9.5mm	5,500	25
97-1200-303	1/2"	12.7x12.7mm	6,500	10



NEW ITEM

ELECTRONIC SPOT WELDER

Order No.	43-3631-0016	43-3631-0025
Type	MSW-16	MSW-25
Rate Input Voltage (V / Hz)	220 / 50	220 / 50
Rated Power (KVA)	16	25
No Load Voltage (V)	1.6-3.2	1.76-3.52
Output Adjustable Steps	7	7
Electrode Pressure (kgs)	135	155
Arm Stretch Length (mm)	400	400
Duty Cycle (%)	20	20
Cooling Water Consumption	0.15Mpa	0.15Mpa
Max Welding Thickness (mm)	1+1-2.5+2.5	1+1-4+4
Cooling Way	By water	By water
Weight	88kg	99kg
Packaging Size (cm)	107x32x99	107x32x99
Price	24,000,000	26,000,000



NEW

Banyak digunakan dalam industri logam, seperti pembuatan kabinet, Suku Cadang Mobil, Suku Cadang Sepeda, Komponen Elektronik, Dll.

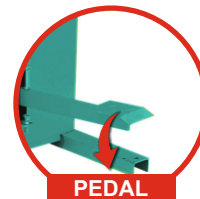
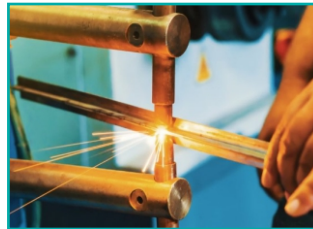

PORTABLE SPOT WELDER

Order No.	43-3631-0008	
Type	MSW-08	
Price	6,000,000	
Input Supply Voltage (VAC)	220±10%	
Frequency (Hz)	50	
Input Capacity (KVA)	2.5	4.0
Duty Cycle (%)	50	30
Secondary No-Load Voltage (V)	1.7	
Max. Output Current (KA)	≤20	
Max. Pressure Force of Electrodes	4~5Kg	
Welding Thickness (mm)	0.5+0.5~1.5+1.5	
Electrodes Arm Length (mm)	200	
Class of Insulation	H	
N.W./G.W.	12.4/14.4 Kg	
Dos	1	
Meas.	47.5x13.8x27cm	

NEW



Berfungsi untuk menyambung dua lembar logam atau lebih. Penyambungan pada lembaran logam dilakukan dengan menggunakan elektroda yang saling berhadapan. Banyak digunakan di bidang otomotif, elektronik, peralatan rumah tangga dan bidang lainnya.

NEW ITEM

SOLDER LISTRIK **HEAVY DUTY** MOD. PISTOL

Order No.	Type	Price	Pak/Dos
67-3235-0500	SLP-500	600,000	1/10

NEW **HEAVY DUTY**

- Power : 500W / 220V~50Hz
- Max. Temperature : 500°C
- Mata Solder : Tembaga
- N.W. / G.W. : 1.1 / 1.2Kg



500W

Alat bantu dalam merakit atau membongkar rangkaian elektronika pada rangkaian yang terdapat pada papan PCB.

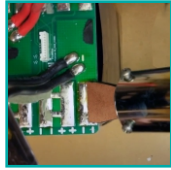

SLP-500

PEMECAH KACA

Order No.	Type	Size	Price	Pak/Dos
78-8800-0835	SH-835	142g	57,000	25/100

NEW

- Base Size : 19.2x7.3cm
- Hammer Size : 17.5x6.3cm
- Dia. of Hammer : Ø14mm
- N.W. / G.W. : 0.17 / 0.185Kg



SH-835

HANGING HOOK



WINDOW BREAKER



SEATBELT CUTTER

PEMECAH KACA

Order No.	Type	Size	Price	Pak/Dos
78-8800-0838	SH-838	210g	85,000	25/100

NEW

- Base Size : 13x8.7cm
- Hammer Size : 22.8x7.8cm
- Dia. of Hammer : Ø17mm
- N.W. / G.W. : 0.24 / 0.25Kg



SH-838



WINDOW BREAKER



SEATBELT CUTTER

NEW ITEM

SINGLE DIP SINUSOIDAL MAGNETIC ABSORPTION DISK

Order No.	Type	Price	Dos
42-1175-0100	SDSM-100	12,760,000	1

NEW

- Can absorb 100N/cm²
- Sucker Size : 100x175mm
- Cutting Angle : 0°-45°
- Weight : 11.5Kg



TILTING



SDSM-100

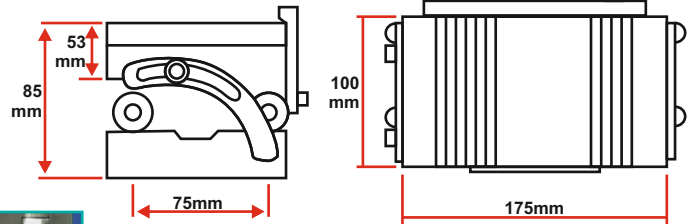

Aplikasi :

- Cocok untuk menggiling dalam sudut presisi tinggi. Cocok untuk memotong logam. Umumnya diterapkan pada pusat permesinan CNC, mesin ukiran dan penggilingan CNC, dan peralatan pemrosesan mekanis lainnya.
- Chuck ini dapat menghidupkan/mematikan gaya magnetik hanya dengan memutar pegangannya.

ROTATING TIP-PROOF PERMANENT MAGNET SUCKER

Order No.	Type	Price	Dos
42-1545-0150	RTP-150	62,400,000	1

NEW

- Can absorb 100N/cm²
- Sucker Size : 150x450mm
- G.W. : 52.3Kg



RTP-150

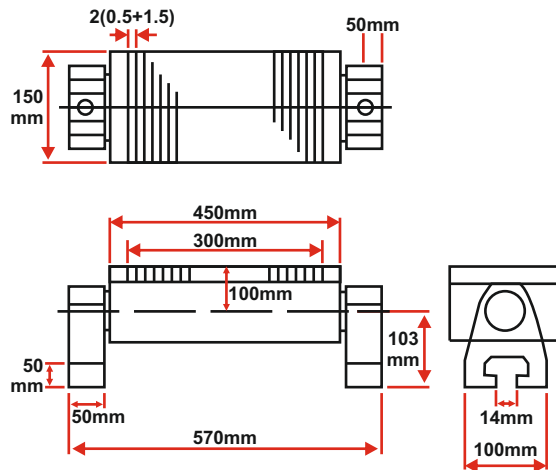

Aplikasi :

- Cocok untuk menggiling dalam sudut presisi tinggi.
- Poros putar dengan graduasi memudahkan penggilingan di sudut mana pun.
- Pencetakan terintegrasi pada bodi mesin dan spindel putar.
- Akurasi permukaan tidak berubah selama pergantian ON/OFF.

SELANG NYLON PA HITAM "WIPRO" TYPE TUBE

Order No.	Type	Price /Roll	Size	Working Pressure	Burst Pressure	Inner Dia.	Outer Dia.	Pak/Dos
26-3882-0604	TUBE-0604	1,000,000	6x4mm x 100M	31Bar	61Bar	4mm	6mm	1/6
26-3882-0806	TUBE-0806	1,200,000	8x6mm x 100M	25Bar	55Bar	6mm	8mm	1/6
26-3882-1075	TUBE-1075	1,800,000	10x7.5mm x 100M	27Bar	54Bar	7.5mm	10mm	1/4
26-3882-1209	TUBE-1209	2,350,000	12x9mm x 100M	31Bar	55Bar	9mm	12mm	1/3
26-3882-1411	TUBE-1411	3,100,000	14x11mm x 100M	21Bar	54Bar	11mm	14mm	1/2
26-3882-1612	TUBE-1612	3,800,000	16x12mm x 100M	19Bar	47Bar	12mm	16mm	-/1

NEW

WIPRO
Professional Tools



TUBE-1612

- Working Temp. : -30°~120°C

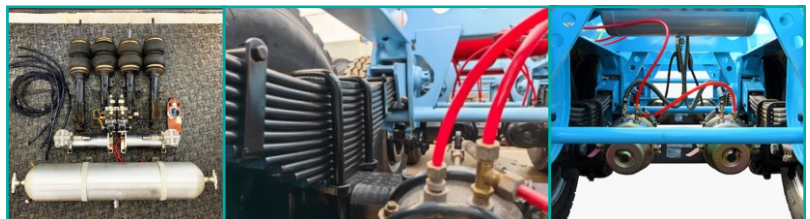

NEW ITEM

MAGNETIC STEEL SHEET SEPARATOR

Order No.	Type	Price	Size LxWxH (mm)	Magnet	Suit For Iron Plate (mm)	Pak/Dos
33-1365-0130	MSSS-130S	3,360,000	F130x130x65	Strong	≤1.2	1/10
33-1365-0131	MSSS-130STR	4,670,000		Stronger	1.2-2.0	1/10
33-1365-0132	MSSS-130SSTR	8,760,000		Super Strong	2.0-6.0	1/10
33-1885-1850	MSSS-185S	2,925,000	F180x108x85	Strong	≤1.2	1/6
33-1885-1851	MSSS-185STR	4,380,000		Stronger	1.2-2.0	1/6
33-1885-1852	MSSS-185SSTR	8,180,000		Super Strong	2.0-6.0	1/6
33-2165-0210	MSSS-210S	5,560,000	F205x155x65	Strong	≤1.2	1/6
33-2165-0211	MSSS-210STR	8,500,000		Stronger	1.2-2.0	1/6
33-2165-0212	MSSS-210SSTR	11,000,000		Super Strong	2.0-6.0	1/6

NEW



MSSS SERIES

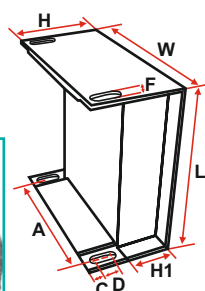
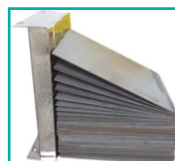

Type	Size (mm)				
	H1	C	D	A	F
MSSS-130S	35	9	21	113	9
MSSS-130STR	35	9	21	113	9
MSSS-130SSTR	35	9	21	113	9
MSSS-210S	35	9	21	138	9
MSSS-210STR	35	9	21	138	9
MSSS-210SSTR	35	9	21	138	9
MSSS-185S	55	9	12	95	9
MSSS-185STR	55	9	12	95	9
MSSS-185SSTR	55	9	12	95	9

• Material : SS201

- Cocok untuk memisahkan tumpukan plat besi tipis atau untuk memisahkan serpihan, dengan prinsip tolakan timbal balik antara kutub magnet yang sama, item ini memungkinkan pemisahan plat besi tipis dengan mudah. Juga berguna untuk pemisahan chip pada belt konveyor kecil.

AMPLAS TANGKAI WIPRO

Order No.	DxHxd1xA (mm)	Grit	Price	Pak/Dos
91-2015-0080	20x15x6x35	AA 80	52,000	10/500
91-2020-0240	20x20x6x35	AA 240	52,000	10/500
91-3015-0060	30x15x6x35	AA 60	57,000	10/400
91-6030-0080	60x30x6x35	AA 80	90,000	10/200
91-6040-0060	60x40x6x35	AA 60	105,000	10/200

NEW SIZE

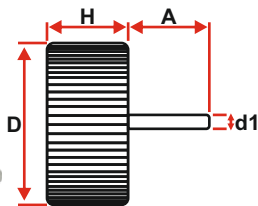

- General-purpose wheel for grinding, polishing, sanding and finishing
- Aluminum oxide mineral cuts sharp, lasts long and finishes fine

TONGKAT PARKIR

Order No.	Type	Price	Pak/Dos
33-1170-0540	TP-500	60,000	1/50

NEW



• Length : 540mm
• Dia. : 40mm
• Power Supply : Battery 1# 1.5Vx2pcs (tidak termasuk battery)
• Color : Red + Black
• N.W. / G.W. : 0.136 / 0.2Kg

- Sakelar tiga tahap menghasilkan lampu mati, berkedip, atau stabil.
- Bodi tahan cuaca terbuat dari plastik tahan benturan
- Tabung dari bahan PP transparan
- Cocok untuk pengatur lalu lintas, lokasi konstruksi, pendakian & kontak berkemah.

LEM PLASTIC STEEL "ARALDITE"

Order No.	Color	Size	Price /Set	Pak/Dos
97-4911-	Hitam	2 x 28.5gr	30,000	12/144



Hasil Mix Clear Putih



Hasil Mix Clear Putih



Hasil Mix Hitam Abu-2

NEW COLOR

ISOLASI DOUBLE FOAM "SEVEN STAR"

Order No.	Size	Warna	Price /Roll	Roll /Dos
108-0034-	24mmx5M	Putih	12,000	108

NEW

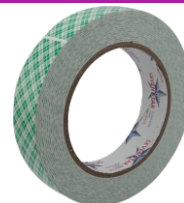

NEW ITEM

UNIVERSAL MAGNETIC BASE

Order No.	Type	Holding Power	Price	Pak/Dos
62-1101-0000	UMS-101		660,000	1/10
62-1105-0000	UMS-105	100Kg	660,000	1/10
62-1106-0000	UMS-106		660,000	1/10

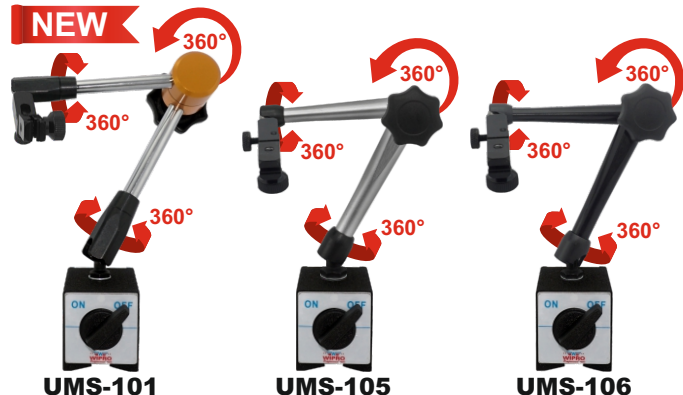

- Main Body LxWxH : 75x50x55mm
- Overall length : 280mm
- Dovetail slot : 6.5mm
- Diameter of Hole : 8+0.02mm
- N.W. / G.W. : 1.5 / 1.7Kg

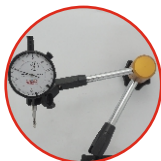

UMS Series

MAGNETIC STANDS

Order No.	Type	Holding Power	Price	Pak/Dos
62-1060-0000	MS-60	80Kg	420,000	1/10

NEW

- Main Body (LxWxH) : 60x50x55mm
- Main Stem (LxDia.) : 176mm/Ø12mm
- Assistant Stem (LxDia.) : 150mm/Ø10mm
- Dovetail slot : 6.5mm
- Diameter of Hole : 4.5/80+0.02mm
- N.W. / G.W. : 1.6 / 1.8Kg



MS-60



MAGNETIC HOLDER

Order No.	Type	Holding Power	Price	Pak/Dos
62-1062-0000	MH-62	80Kg	310,000	1/10

NEW



- Main Body (LxWxH) : 60x50x55mm
- Dovetail slot : 6.5mm
- Diameter of Hole : 4.5/80+0.02mm
- N.W. / G.W. : 1.2 / 1.3Kg

MH-62 bisa dipasangkan dengan type UMS-101, 105 & 106 dan juga ke type MS-60

V-BLOCK TRIANGLE MAGNETIC

Order No.	Type	Holding Power	Price	Pak/Dos
62-1125-0000	VBT-125	60Kg	1,200,000	1/5

NEW



- Main Body (LxWxH) : 125x60x72mm
- N.W. / G.W. : 1.8 / 2Kg

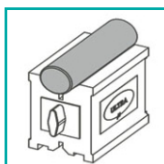

VBT-125

Fungsi : Untuk mencekam benda kerja di proses milling

SQUARE TYPE MAGNETIC BLOCK

Order No.	Type	Holding Power	Price	Dos
62-1100-0000	SMB-100	25Kg	7,160,000	1
62-1150-0000	SMB-150	50Kg	13,550,000	1

NEW



Type	Main Body (LxWxH)	N.W. / G.W.
SMB-100	100x100x100 mm	7.5 / 8.5Kg
SMB-150	150x150x150 mm	22 / 23Kg



SMB Series

Fungsi : Untuk mencekam benda kerja di proses milling

NEW ITEM

BAKI CAT ROLL

Order No.	Price /Dzn	Pak/Dos
112-0002-	250,000	1/4

NEW



• Dimension :
365x280x80 mm



SISI SERONG

SISI SAMPING

SISI ATAS

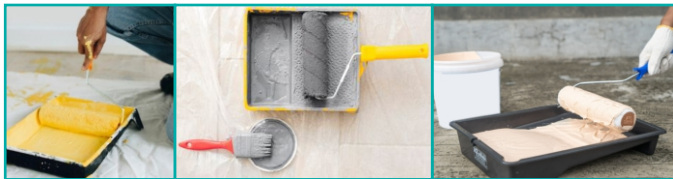

UNIVERSAL MACHINE VICE

Order No.	Type	Price	Dos
21-0105-0000	UMV-105	9,200,000	1

NEW

- The accuracy of vice (parallelism and squareness) : 0.025mm/100mm
- Dapat dimiringkan 90° dan diputar 360°
- Material : 45#
- Width of Jaw. : 105mm
- Height of Jaw : 40mm
- Max. Opening : 105mm
- N.W./G.W. : 23/24Kg
- Meas. : 48x23x21cm



UMV-105



TIPTRONIC HYDRAULIC POWER MACHINE VICE

Order No.	Type	Price	Dos
52-0320-0000	THP-MV320	11,000,000	1

NEW

- The accuracy of vice (parallelism and squareness) : 0.025mm/100mm
- Material : 45#
- Width of Jaw. : 152mm
- Height of Jaw : 52mm
- Max. Opening : 320mm
- N.W./G.W. : 42/43Kg
- Meas. : 62x26x17cm



THP-MV320



NEW ITEM

PRECISION STEEL PARALLELS SET 16 PCS

Order No.	Type	Price /Set	Dos
31-6181-0616	PSP-16	2,925,000	2

NEW

- Parallelism 0.005mm, accuracy 0.01mm
- Size : 8pcsx2
- Material : 65Mn & 40Cr
- Hardness : HRC52-62
- Precision : 0.01
- Parallel : 0.005
- N.W. / G.W. : 10 / 10.5Kg



Including
5x16x100mm : 2pcs
6x18x100mm : 2pcs
8x24x100mm : 2pcs
10x30x100mm : 2pcs
12x36x150mm : 2pcs
14x48x150mm : 2pcs
18x60x150mm : 2pcs
22x62x150mm : 2pcs



PSP SERIES



PRECISION STEEL PARALLELS SET 18 PCS

Order No.	Type	Price /Set	Dos
31-6181-0618	PSP-18	1,850,000	4

NEW

- Parallelism 0.005mm, accuracy 0.01mm
- Size : 8.5x14~44x150mm(18pcs)
- Material : 40Cr
- Hardness : HRC52-62
- Precision : 0.01
- Parallel : 0.005
- N.W. / G.W. : 5.5 / 5.75Kg



Including
8.5x14x150mm : 2pcs
8.5x16x150mm : 2pcs
8.5x20x150mm : 2pcs
8.5x24x150mm : 2pcs
8.5x30x150mm : 2pcs
8.5x32x150mm : 2pcs
8.5x36x150mm : 2pcs
8.5x40x150mm : 2pcs
8.5x44x150mm : 2pcs



PSP SERIES



PRECISION STEEL PARALLELS SET 36 PCS

Order No.	Type	Price /Set	Dos
31-6181-0636	PSP-36	4,650,000	2

NEW

- Parallelism 0.005mm, accuracy 0.01mm
- Size : 8x16~50x150mm (36pcs)
- Material : 40Cr
- Hardness : HRC52-62
- Precision : 0.01
- Parallel : 0.005
- N.W. / G.W. : 12 / 12.5Kg



Including	
8x16x150mm : 2pcs	8x34x150mm : 2pcs
8x18x150mm : 2pcs	8x36x150mm : 2pcs
8x20x150mm : 2pcs	8x38x150mm : 2pcs
8x22x150mm : 2pcs	8x40x150mm : 2pcs
8x24x150mm : 2pcs	8x42x150mm : 2pcs
8x26x150mm : 2pcs	8x44x150mm : 2pcs
8x28x150mm : 2pcs	8x46x150mm : 2pcs
8x30x150mm : 2pcs	8x48x150mm : 2pcs
8x32x150mm : 2pcs	8x50x150mm : 2pcs



PSP SERIES

PRECISION WIRE CUT VISE

Order No.	Type	Price	Dos
83-1632-0100	PCV-100	16,800,000	3

NEW

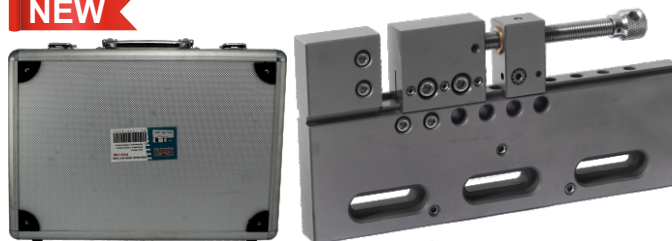

- Material : SUS440
- Clip to hold scope : 0-100mm
- Parallelism : 0.003m/100mm
- Squareness : 0.005m/100mm
- Weight : 5Kg

Catok penjepit untuk mesin Wire EDM dengan baja tahan karat, khusus untuk stabilitas dan kekakuan tinggi. Pasang sekrup untuk tujuan penyetaraan benda kerja dengan cepat



PCV-100

Size A	270mm
Size B	135mm
Size C	23.7mm
Size D	55mm
Size E	50mm
Size F	30mm
Size Max G	105mm

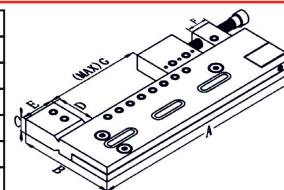

NEW ITEM

ER PUNCH FORMER

Order No.	83-5340-0040
Type	ERPF-40
Price	15,670,000
Size	ER40
Chuck Clamping	Ø2-Ø70mm
Center Height	80-81mm
Through Hole Diameter	Ø16mm
Spindle Accuracy	Within 0.002mm
Accuracy of Collet	Within 0.008mm
Collet (5pcs)	6, 10, 16, 20, 25mm
Weight	7.2Kg
Dos	1

NEW

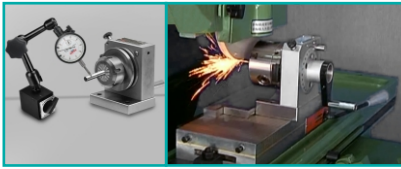

ERPF-40

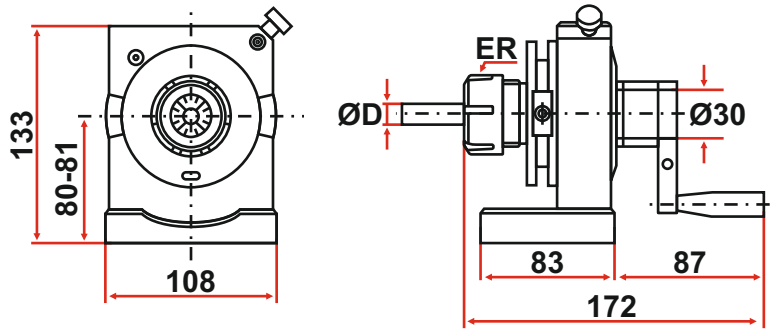

PUNCH FORMER

Order No.	83-1606-0080
Type	PF-80
Price	14,550,000
Size	80mm
Chuck Clamping	Ø2-Ø70mm
Center Height	80-81mm
Through Hole Diameter	Ø16mm
Swivel Diameter of Main Seat	Within 0.003mm
Repetitive Clamping Accuracy of Three-Jaw Chuck Aperture	0.015mm
3-Claw Aperture	Ø16mm
Minimum Clamping Diameter	Outer Diameter : Ø 2mm Inner Diameter : Ø24mm
Maximum Clamping Diameter	Outer Diameter : Ø70mm Inner Diameter : Ø64mm
Weight	7.17Kg
Dos	1

NEW

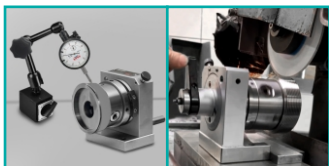
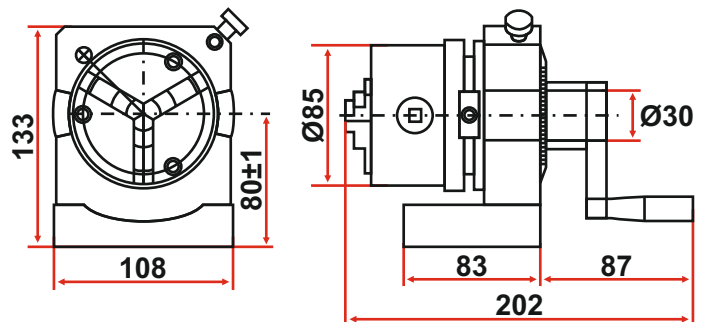
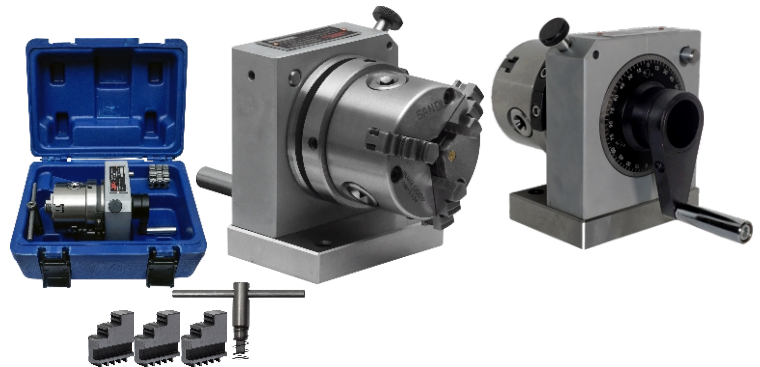

PF-80

NEW ITEM

CORE CHUCK GRINDER

Order No.	Type	Size	Price	Dos
33-0515-0000	CCG-0515	5-15mm	120,000	10
33-2036-0000	CCG-2036	20-36mm	160,000	10

NEW



Type	Inner Dia.	Outer Dia.
CCG-0515	19mm	35mm
CCG-2036	43mm	63mm

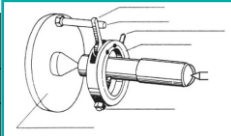

CCG SERIES

FV FREESTYLE VICE

Order No.	Type	Price /Set	Dos
45-6262-0192	FV-FV-192	8,600,000	2

NEW



1Set = 2Pcs

- Material : 45#
- KN : 28KN
- N.W./G.W. : 26/27Kg
- Meas : 41x24x11cm

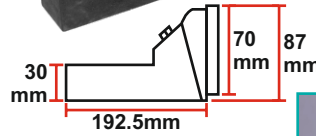

FV-FV-192

VERTICAL & HORIZONTAL ROTARY TABLE

Order No.	Type	Price	Table Size	Max. Load (Hor./Vert.)	T-Slot	Weight (kg)
62-2804-0150	VHRT-150	6,450,000	ø150mm	100/50Kg	4 Pcs	14
62-2804-0200	VHRT-200	9,400,000	ø200mm	150/75Kg	4 Pcs	28
62-2804-0250	VHRT-250	12,400,000	ø250mm	200/100Kg	4 Pcs	43
62-2804-0300	VHRT-300	18,325,000	ø300mm	250/125Kg	6 Pcs	71
62-2804-0400	VHRT-400	39,600,000	ø400mm	350/175Kg	6 Pcs	93

NEW

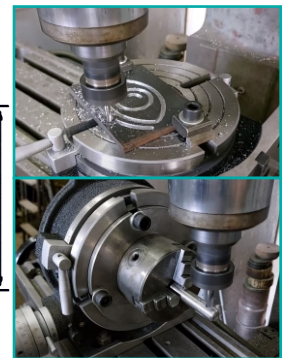
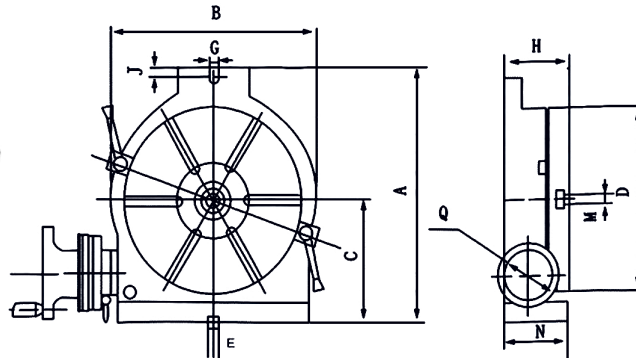

VHRT Series

- Fungsi :
 1. Membentuk lingkaran atau radius
 2. Membagi jarak lubang atau alur
 3. Membagi bidang segi banyak beraturan dan tidak beraturan
 4. Dilakukan berdasarkan sudut tertentu dalam satu keliling lingkaran pada pusat sumbu.

Type	Size (mm)									
	A	B	C	D	E	G	H	J	M	N
VHRT-150	200	160	100	ø150	16	16	86	10	MT2	78
VHRT-200	265	220	135	ø200	16	17	105	15	MT3	98
VHRT-250	325	280	165	ø250	16	17	120	15	MT3	110
VHRT-300	388	330	195	ø300	16	17	135	/	MT4	130
VHRT-400	525	390	260	ø400	16	22	145	/	MT4	130

NEW ITEM

AUTOMATIC CENTER PUNCH

Order No.	Type	Size	Price	Pak/Dos
63-3428-0130	ACP-130	130mm	42,000	1/100

NEW

- Punch Material : 60CR-V
- Hardness : HRC58
- N.W. / G.W. : 0.075 / 0.085Kg

- Alat ini berguna untuk memberi penanda titik sebelum mulai mengebor, dengan penanda titik maka hasil bor akan lebih rapi dan akurat. Cara menggunakan sangat mudah, cukup tekan kebawah dan sistem spring akan otomatis melakukan pukulan kuat untuk membuat objek yang ditekan berlubang.



ACP-130

AUTOMATIC CENTER PUNCH

Order No.	Type	Size	Price	Pak/Dos
63-3428-0132	ACP-132	132mm	43,000	1/100

NEW

- Punch Material : 60CR-V
- Hardness : HRC58
- N.W. / G.W. : 0.072 / 0.082Kg

- Alat ini berguna untuk memberi penanda titik sebelum mulai mengebor, dengan penanda titik maka hasil bor akan lebih rapi dan akurat. Cara menggunakan sangat mudah, cukup tekan kebawah dan sistem spring akan otomatis melakukan pukulan kuat untuk membuat objek yang ditekan berlubang.

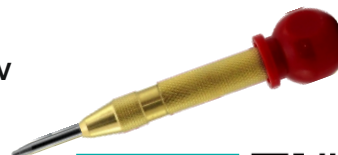

ACP-135

PORTABLE CHAMFER

Order No.	49-0250-0000	49-0750-0000
Type	PCH-250	PCH-750 (BRUSHLESS)
Price	10,500,000	19,100,000
Voltage	220V~50Hz	220V~50Hz
Power	250W	750W
Chamfering Range	0-3mm	0-9mm
Chamfering Angle	15°-45°	15°-45°
Speed	2800RPM	3000-6000RPM
N.W. / G.W.	12 / 14Kg	12.5 / 14.5Kg
Dos	1	1

- PCH-250 : One-time Maximum Chamfer Range 2-3mm
- PCH-750 : One-time Maximum Chamfer Range 4-5mm

NEW



PCH-250



SWITCH ON OFF



PCH-750
(BRUSHLESS)
MOTOR



PCH-750

BENCH CHAMFER

Order No.	49-0251-0000	49-0551-0000
Type	BCH-250	BCH-550 (BRUSHLESS)
Price	13,150,000	29,700,000
Voltage	220V~50Hz	220V~50Hz
Power	250W	550W
Chamfering Range	0-3(6)mm	R1-R4/C3
Chamfering Angle	15°-45°	
Speed	2800RPM	3000-6000RPM
N.W. / G.W.	35 / 36Kg	27 / 28Kg
Dos	1	1

NEW



BCH-250



BCH-250



BCH-550 (BRUSHLESS)

BRUSHLESS MOTOR

Mampu melakukan talang pada benda kerja sudut R dan sudut c, satu mesin untuk dua fungsi.

R Angle chamfer effect

Straight chamfer effect